

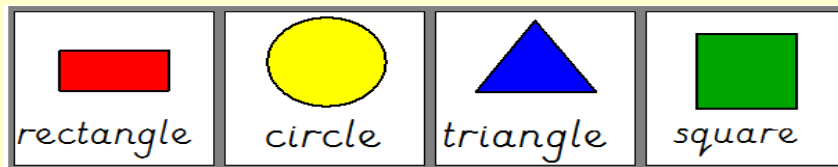



 = 
 and have 
 sides and 
 corners.



2D shapes are flat and have sides and corners.

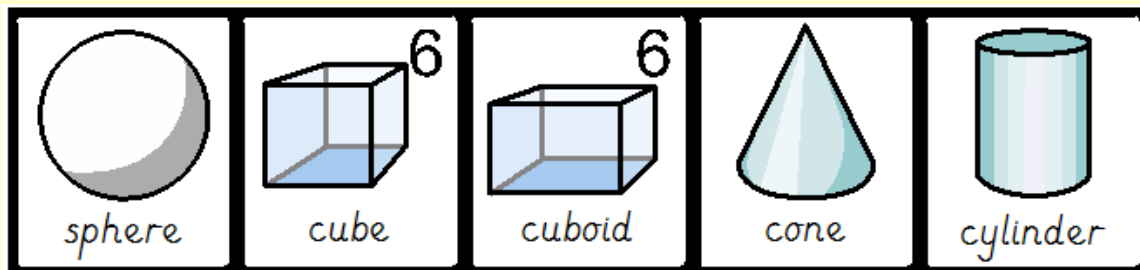

 = 

 These are 3D shapes.



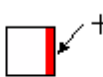
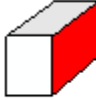

~~=~~ 
 and have 
 sides, 
 corners and 
 faces.

3D shapes are not flat and have sides, corners and faces.

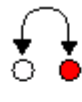

Print



or



draw



the shape nets.



Fold



the

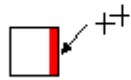

edges



and



make



the 3d shapes.

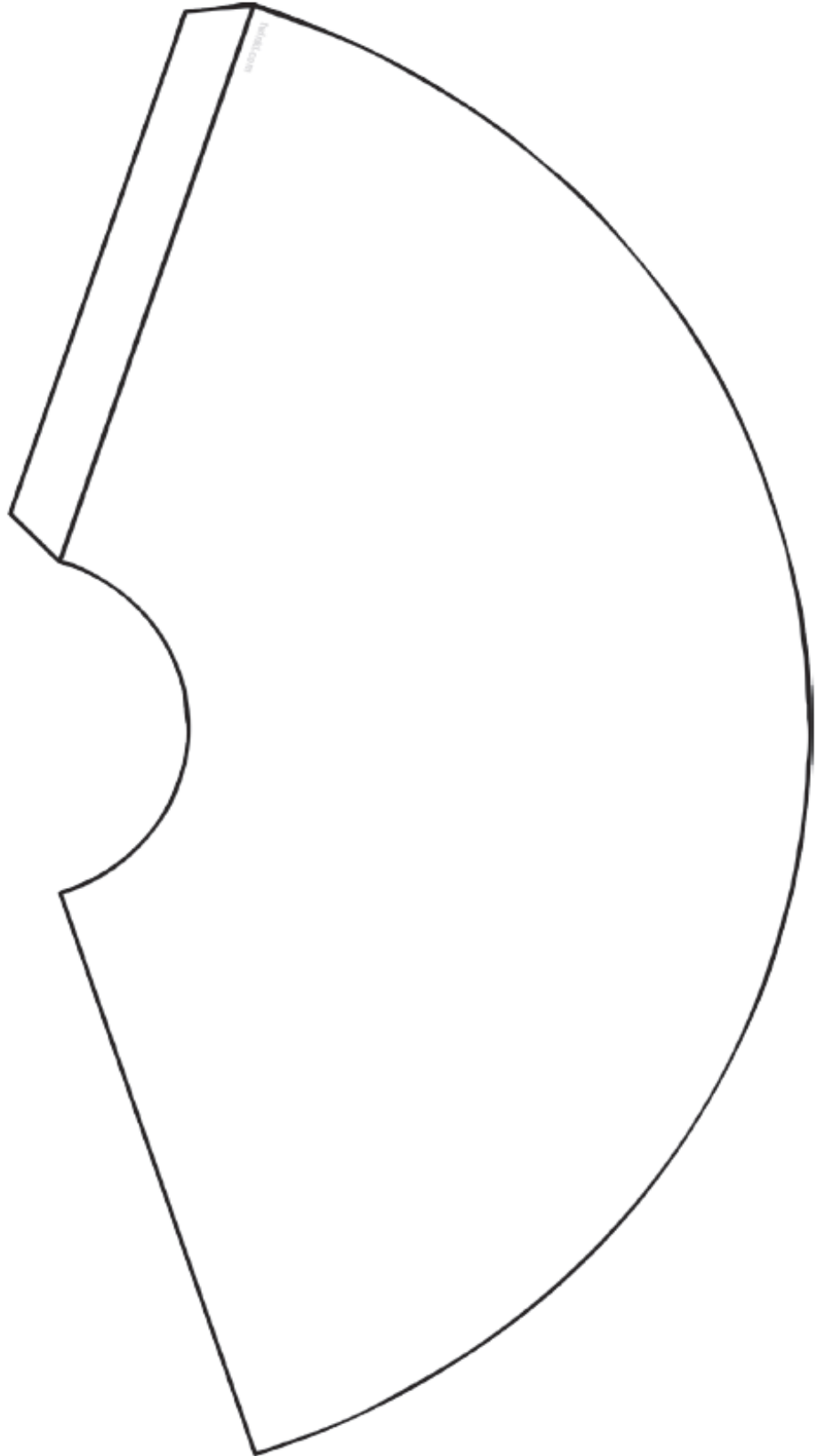

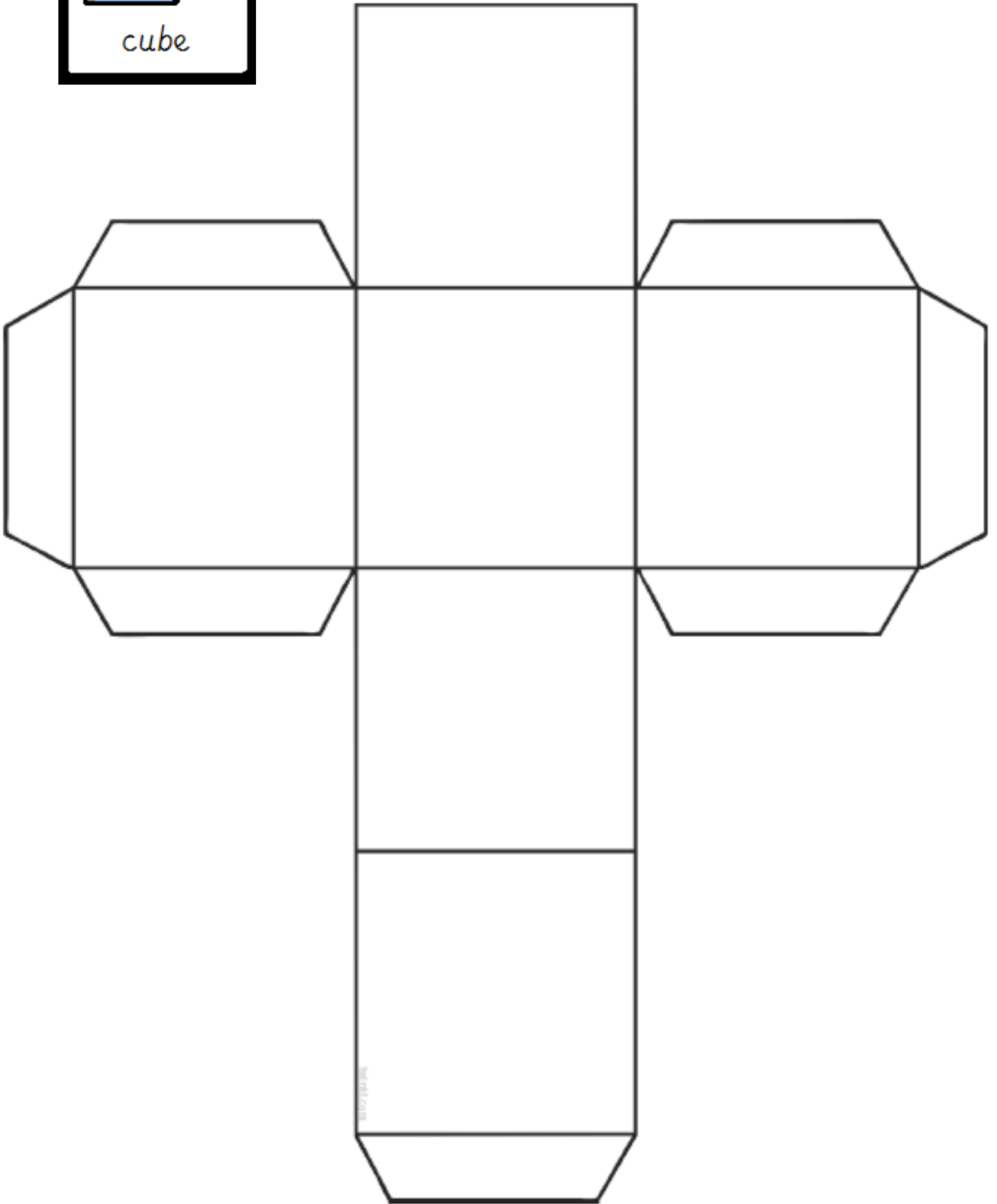
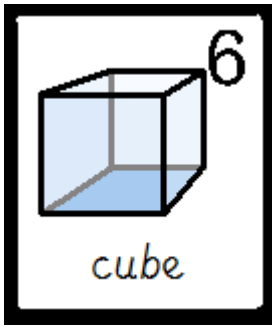

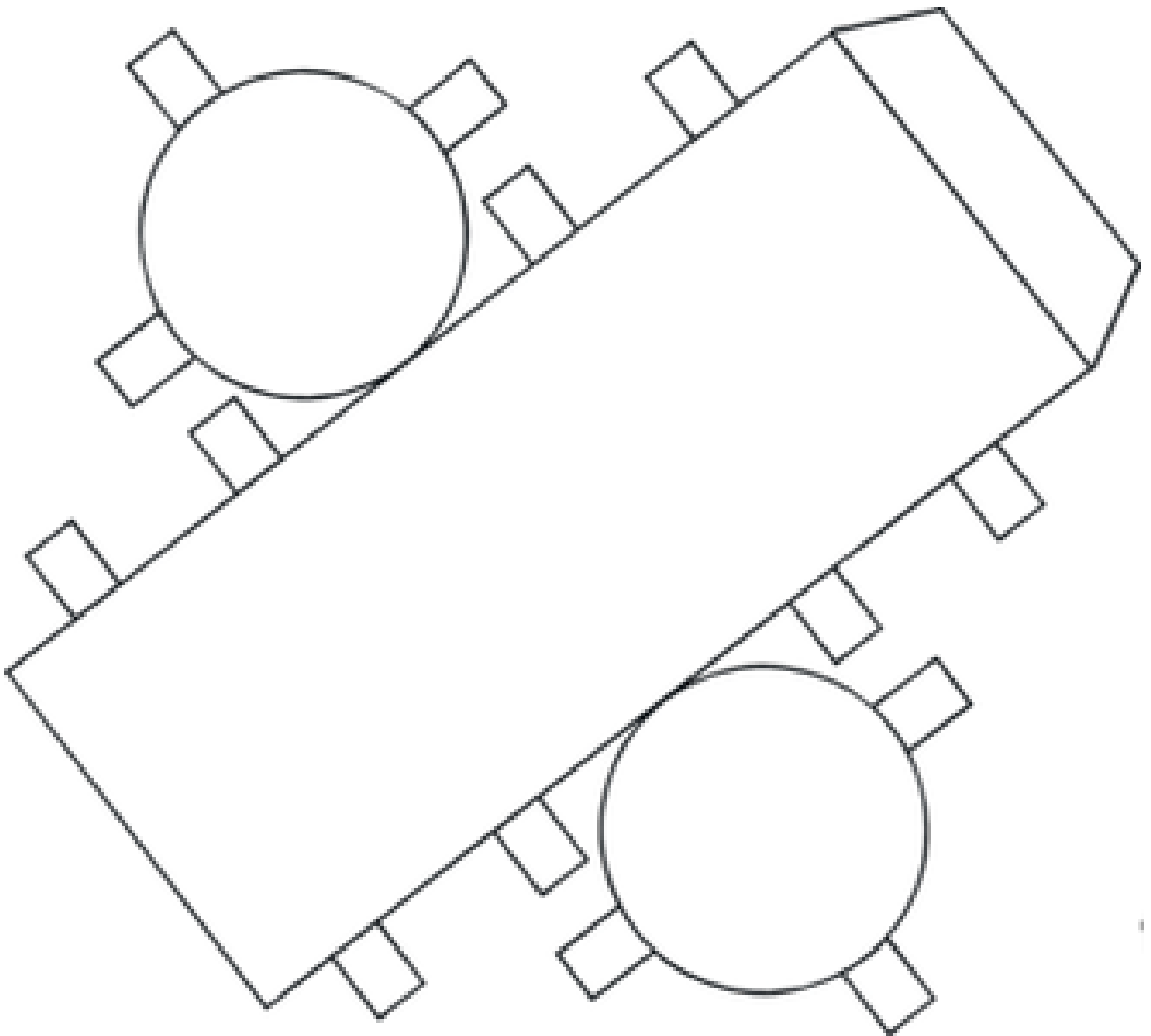
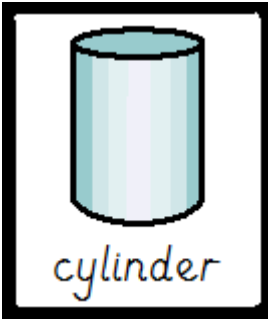

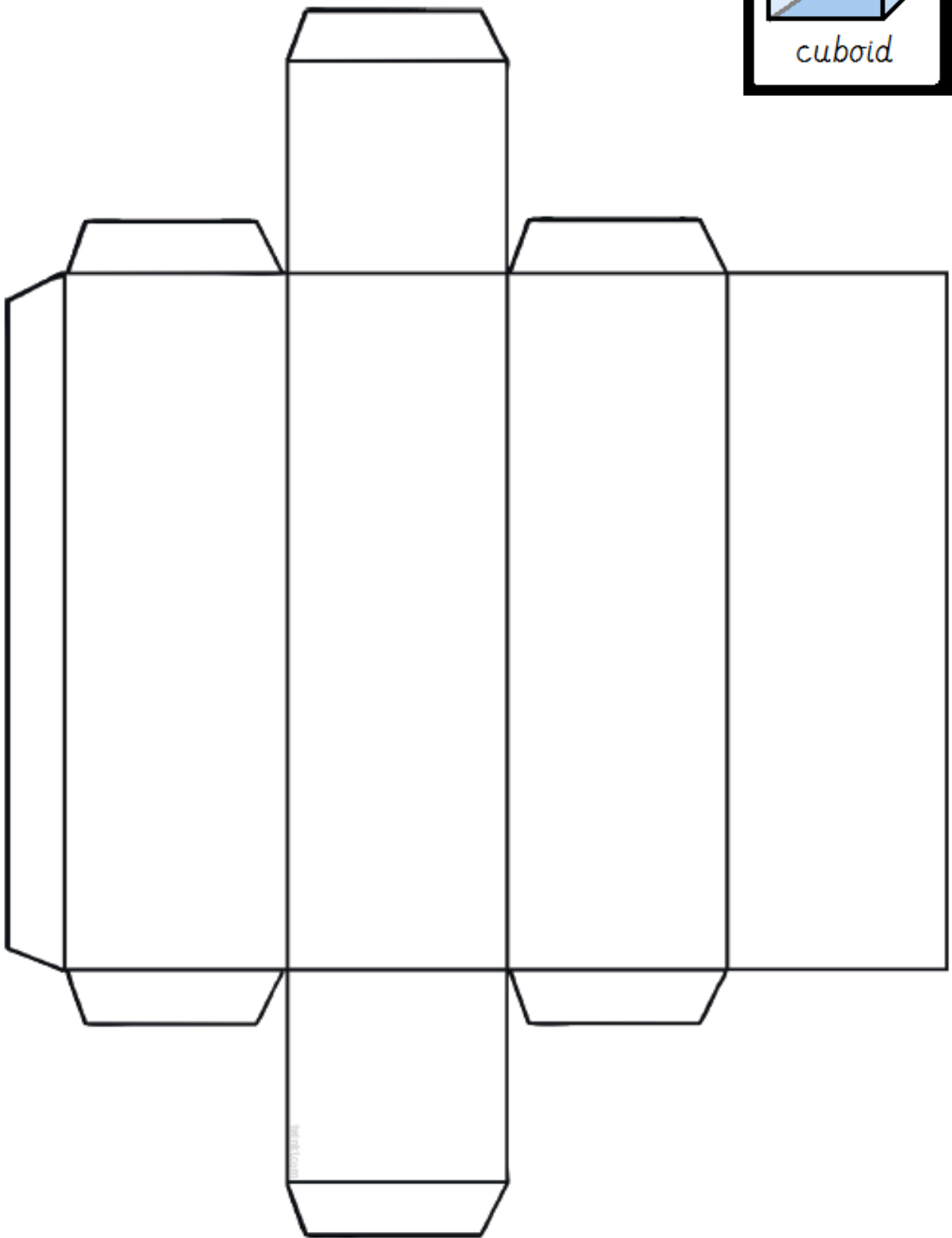
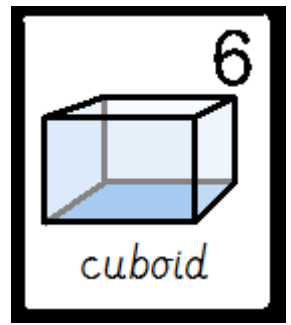

























Tuesday English



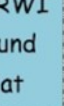

1. Say the sounds.

| | | | | | | | | |
|--|--|--|---|---|--|---|--|--|
|  Maisey mountain mountain |  Around the apple, down the leaf |  Slither down the snake |  Round his bottom, up his tall neck and down to his feet |  Down the tower, across the tower |  Down the body, dot for the head |  Down Nobby and over his net |  Down the plait and over the pirate's face |  Round her face, down her hair and give her a curl |
|  All around the orange |  Curl around the caterpillar |  Down the kangaroos body, tail and leg |  Down and under, up to the top and draw a puddle |  Down the laces, to heel, round the toe |  Down the stem and draw the leaves |  Lift off the top and scoop out the egg |  Down the long leg |  Down the head, to the hooves and over his back |
|  Down his back, then curl over his arm |  Down the body, curl and dot |  Down a wing, up a wing |  Down a horn, up a horn and under his head |  Down up, down up |  Zig-zag-zig |  Round her head, up past her earrings and down her hair |  Down the arm and leg, repeat the other side | |

My RWI Sound Mat

BYRON WOOD ACADEMY
Astrea Academy Trust
INSPIRING BEYOND MEASURES

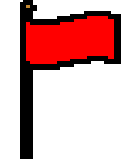
2. These words have 4 sounds.

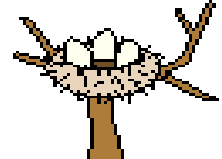
| | | |
|---|---|---|
|  crab |  frog |  flag |
|  drum |  sink |  nest |

3. Say the sounds and blend them to read the words.

4. Match the words and pictures.



frog

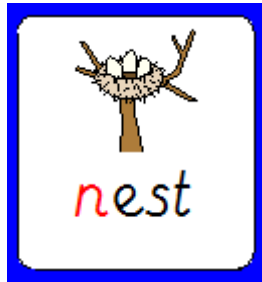

crab



drum



nest



sink



flag